

**Instruction Manual**

**PilotGenizer Ultrahigh Pressure Homogenizer**

Catalog No. PilotGenizer

**3 Steps for running the Pilot Genizer**

**Step 2:** Adjust the Speed from Low to High

**Step 1:** Sample from Inlet

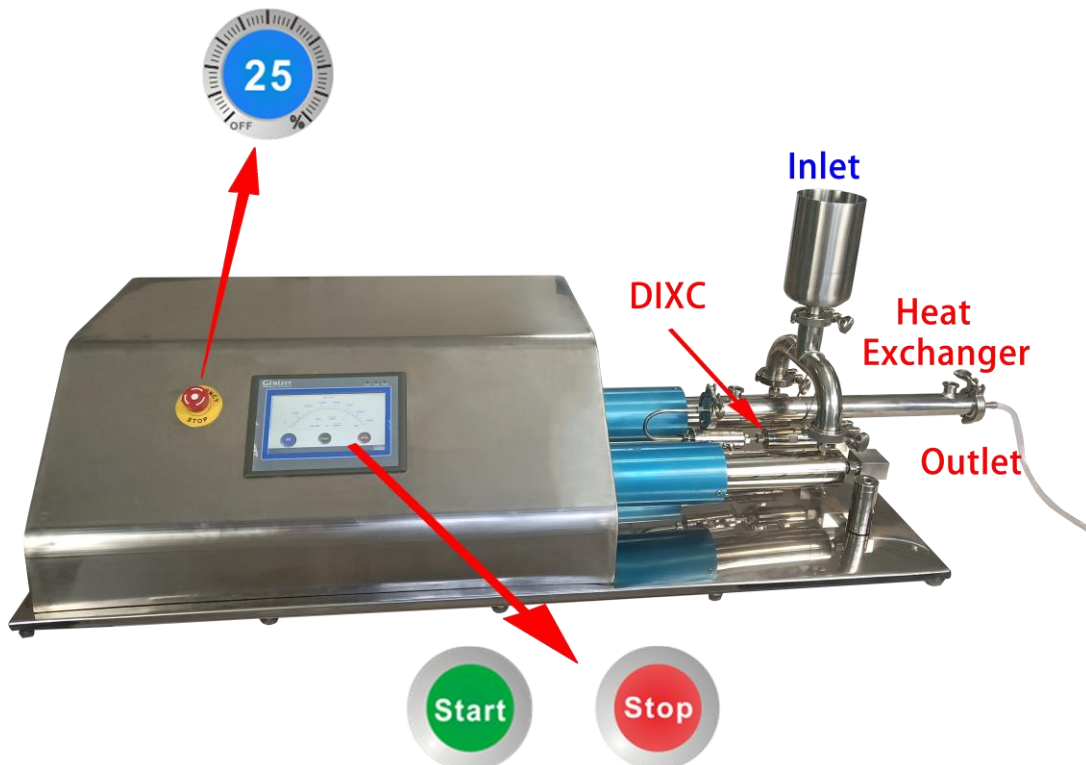

**Step 3:** Press the Start or Stop



## 1. Open-box Inspection

Check whether there is any packing damage. Refer to the shipping list for the integrity of the product.

## 2. Product Introduction

### 2.1 Brief Introduction

PilotGenizer series electric ultrahigh pressure homogenizer is an ultrahigh pressure homogenizer equipment operated with the touch screen and controlled intelligently by program. It can be used for production preparation of fat emulsion, liposome, nano suspension, micro emulsion, lipid microsphere, nanoemulsions, dairy products, infusion solutions, cell disruption, juice homogeneity, fine chemical engineering, dye and etc. The maximum working pressure is 45000 Psi/3100 Bar. All parts touching with medium are 316L stainless steel, 17-4ph stainless steel, titanium alloy, tungsten carbide; PTFE, UHMWPE or other corrosion resistance materials.

### 2.2 SPECIFICATIONS

Catalog No.	Pilot15k	Pilot20k	Pilot25k	Pilot30k	Pilot45k
Max. Flow rate	30L/hr	30L/hr	20L/hr	20L/hr	20L/hr
Min. Sample	50ml	25ml	25ml	25ml	25ml
Max. Pressure	15,000psi	20,000psi	25,000psi	30,000psi	45,000psi
Dimensions(cm)	130×60×35	130×60×35	130×60×35	130×60×35	130×60×35
Weight	~120 kg	~120 kg	~120 kg	~120 kg	~120 kg
Max. Temp.	80 °C (176 F)				
Power	380V-440V				



## Instruction Manual PilotGenizer Series

---

Cleaning	Flush to clean
Application	Nano emulsion, Fat emulsion, Liposome, Cell Disruption, Nano dispersion, Deagglomeration, Graphene, MLCC
Features	Digital display of pressure or pressure gauge

---

### STANDARD FEATURES

---

Parts	Y-type Diamond interaction chamber with cooling option
Control System	High pressure programming control systems <sup>®</sup> : Touch Screen, Speed control, Auto stop control by volume, time, pressure or temperature, settable volume control as low as 100ml, display of flow rate and time, overload protection
Pressure Gauge	Electric
Inlet type	2" Tri clamp
Outlet type	2" Tri clamp
Feed Reservoir	1L Stainless Cylinder
Collector Reservoir	N/A
Product material	316L stainless steel, Tungsten Carbide, Viton, Teflon
Material standard	Pharmaceutical Grade, FDA, GMP
Warranty	1 year against any manufacturing defects

---

### OPTION FEATURES

---

Parts	High Pressure Extruders, Homogenizing valves two stages, Heat Exchanger
Control System	Tradition mechanical control; Speed, start, stop control
Detector	Pressure gauge, Pressure transducer, Temperature transducer
Outlet type	Tri-Clamp or Luer or High Pressure fittings

---

---

Feed Reservoir	2L, 3L, 5L, 10L Stainless Cylinder or Online
Collector Reservoir	2L, 3L, 5L, 10L Stainless Cylinder or Online
Cylinder	Titanium High pressure Cylinder (Resistant to strong acid and base)

---

### 3. Safety Instructions:

The user should NOT point the inlet and outlet of high pressure devices and equipments supplied by the Genizer, including high pressure homogenizer, extruder, interaction chamber and valve, to any personnel and object which may induce the safety issue and property loss. The personal shield is recommended in the operation of high pressure homogenizer and extruder. Also, the high pressure homogenizer and extruder are recommended to be operated in the shielded hood or space.

Instructions of "attention", "warning", "danger"

 **Attention:** Indicate the correct procedures and practices for operation and maintenance, to avoid damage to the equipment or other properties.

 **Warning:** Potential Danger. Correct procedures and practices need to be followed to avoid personal injury.

 **Danger:** The improper handling could cause hazardous condition, such as serious personal injuries, damage to the equipment or even loss of life.

 **Warning:** The equipment or the components cannot be changed without authorization.

 **Warning:** It's necessary to completely read the user manual

before operating the PilotGenizer series electric ultrahigh pressure homogenizer. The operator should be familiar with all the functions and control of this system.

 **Warning:** Please wear the proper individual protective gear when operating the PilotGenizer series electric ultrahigh pressure homogenizer.

 **Warning:** Do not exceed the rated range. The PilotGenizer series electric ultrahigh pressure homogenizer has designed maximum working pressure. Once exceeding, it would cause the equipment damage and personal injury.

 **Warning:** Do not screw up the firmware or move the equipment when the equipment is running or is under pressure.

 **Warning:** Do not use the broken component and replace it in time.

 **Warning:** The working pressure of this system should not exceed the maximum pressure of the rated component of this system. The pressure gauge is installed in the system for checking the pressure condition of the system anytime.

 **Warning:** DO NOT point the inlet and outlet of high pressure devices and equipments supplied by the Genizer, including high pressure homogenizer, extruder, interaction chamber and valve, to any personnel and object which may induce the safety issue and property loss. The user and buyer should completely responsible for the violation of the clause

and recommendation besides any other unsafe practices.

 **Warning:** Handle the equipment gently and do not put heavy things on the equipment.

 **Attention:** Keep the PilotGenizer series electric ultrahigh pressure homogenizer far away from the open fire and high temperature. The overheated environment would damage the sealing element, hosepipe and parts of the electric appliance components. The performance of the homogenizer will be influenced if the temperature is higher than 60°C.

 **Danger:** The parts cannot be fixed only by the force of close-fitting. It could cause personal injuries by popping when the system pressure is too high.

 **Warning:** PilotGenizer series electric ultrahigh pressure homogenizer should be maintained by qualified technician. The user should be responsible for any improper maintenance.

 **Warning:** Using original parts to replace worn or damaged parts. Replacement with non-original parts will not be warranted.

## 4. Preparation

4.1 Make sure all connectors and hoses, electric wirings are in correct position. The rated pressure class of connectors and hoses should be followed, and the power-supply wiring should use the rated voltage and

current.

4.2 The tightness degree of all thread connections should in moderate, not too loose or too tight.

4.3 Make sure all pipe fittings are connected properly to the outlet and inlet, which should not exceed the load of ultrahigh pressure homogenizer.

4.4 The medium must be compatible with 316L stainless steel. Please refer to the engineering manual or consult with the manufacturer for details. The following is the medium that can be used:

- Distilled Water
- Soluble oil (water-in-oil emulsion)
- Petroleum
- Alcohol
- Diester
- Acetone
- Silicone Oil
- Lipids
- Surfactants
- Other organic solvent
- Strong Acids and Base  **Titanium cylinder needed**

 **Attention:** The large area of corrosion damage of ultrahigh pressure homogenizer caused by improper use of medium is not covered in the warranty.

## **5. Installation**

PilotGenizer series electric ultrahigh pressure homogenizer is an ultrahigh

pressure homogenizer equipment operated on the touch screen and controlled intelligently by PLC. The power supply for the whole set of the equipment is 380V-440V. The homogenizer should be installed according to the part drawing in the Components List.

 **Warning:** Fail to follow the chapter 5 might lead to personal injuries or damage to the equipment.

### 5.1 Placement of the homogenizer

The equipment is heavy and should be placed on a stable platform. The equipment has non-slip foot-pads which do not need other fixing methods. The equipment requires extra space for safety and convenient operation.

### 5.2 Assembly of the homogenizer

Most of the components of this equipment have been assembled before leaving factory. Some peripherals with different joint pipes according to the special requirements of user should be assembled by operator. For details, please refer to the component detailed parts drawing of *Components List* for assembling.





Figure 1

- 1) Please refer the assembled drawing to Figure 1.
- 2) Remain two-three circles of threads when screw the collar as indicated in the Figure 2.

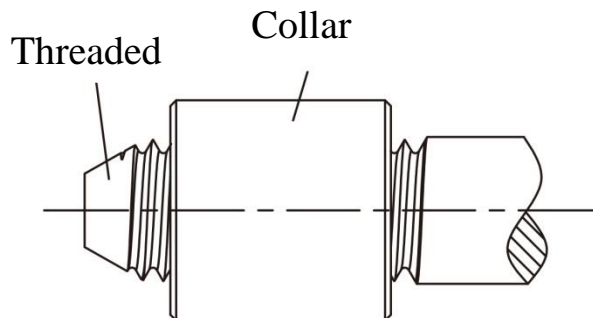

Figure 2

- 3) When installing the one-way check valve of outlet, please connect the pump body at first, and then connect the high pressure fitting and T-junction. Meanwhile, please pay attention to the installation direction of

the one-way check valve of outlet.

### 5.3 Disassembly of the seal parts

Replacement of the seal parts is needed when the seal parts is worn out. If the high pressure cylinder has bolts, then use the Allen wrench to disassemble the bolts. In other case, please disassemble the high pressure cylinder of the homogenizer as indicated in Figure 3.

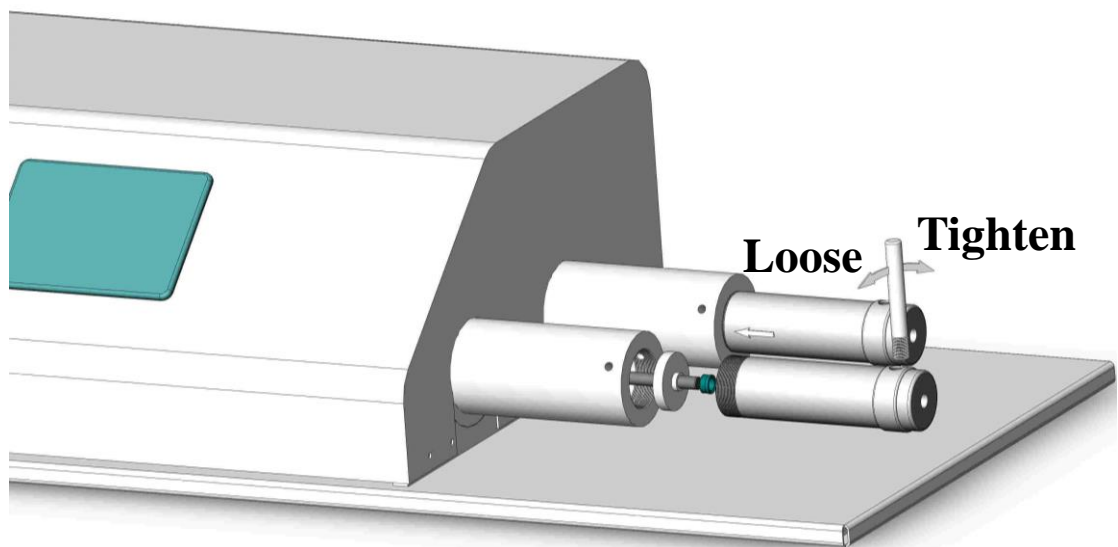

Figure 3

Disassembly of the seal part is indicated in the Figure 4 and Figure 5.

First, put the disassembling tool ① into the pump body; after then, put

the disassembling tool ② into the hole of the disassembling tool ① up to the end; At last, pull the whole assembly ③ out as shown in Figure 5.



Figure 4 Piston and Seal

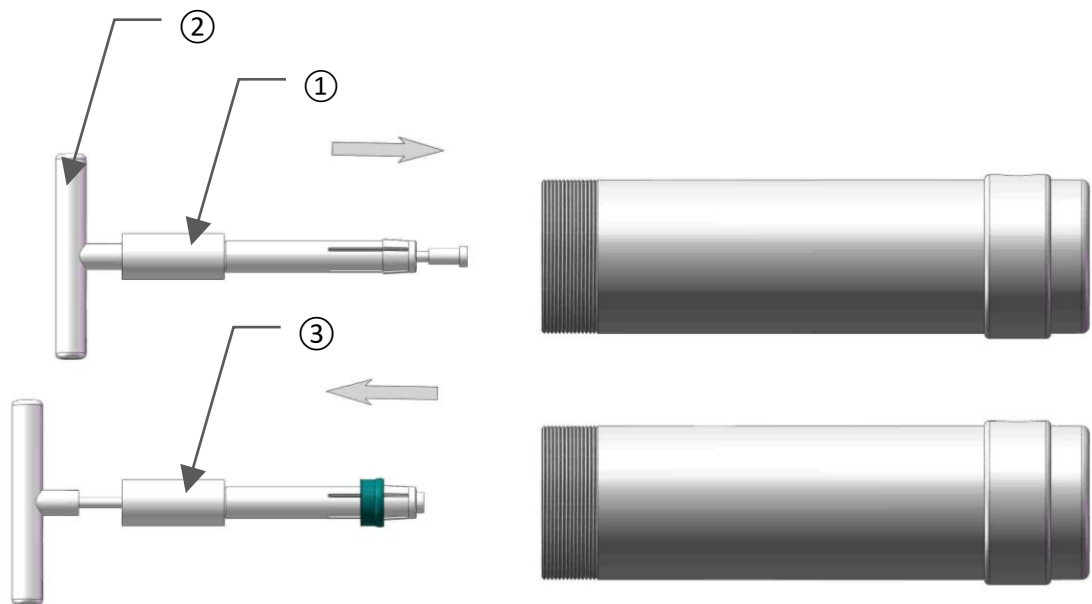

Figure 5

#### 5.4 Installation of the seal part

As showing in the Figure 6, when the set of the seal part is on the top of the installing tool of the sealing element, please use the palm to lightly push the installing tool until the assembly of the seal part is inside the pump body.

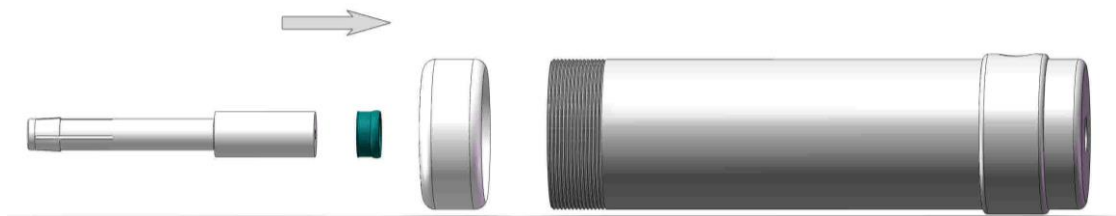

Figure 6

## 6. Operation

PilotGenizer has two optional types: traditional type and standard type (Figure 7). The control system of the traditional type homogenizer contains three buttons and one scale rotary knob, which is respectively the green start button, the red stop button, the red emergency stop button with mushroom head and the scale rotary knob for the adjustment of speed and pressure. While the control system of the standard type homogenizer contains one touch screen and one red emergency stop button with mushroom head in total.

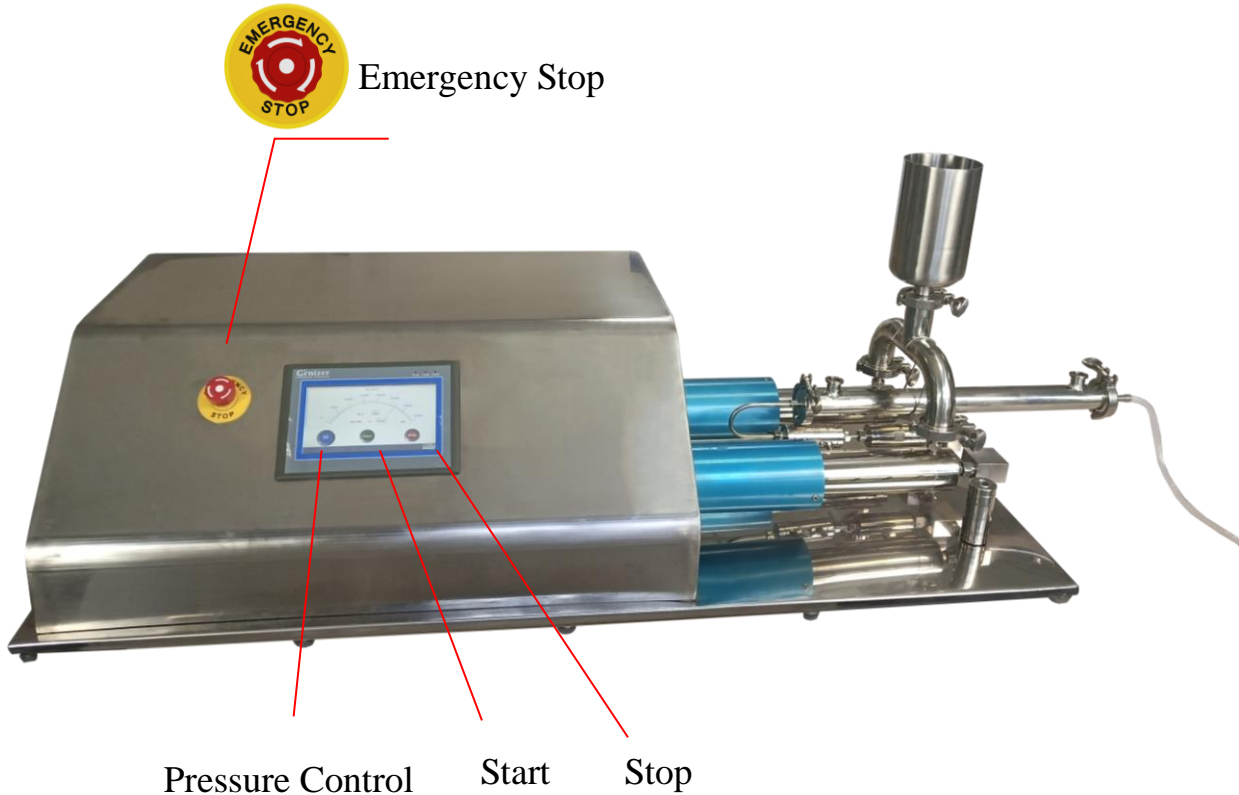

Figure 7

### 6.1 Operation instruction of the traditional type homogenizer

First, connect to the electrical outlet; when the red power light is on, switch on the power at the left of the ultra-high pressure homogenizer. Once the PLC is ready, push the green start button, the homogenizer will start homogenizing the raw material. The power can be controlled by the scale rotary knob for speed and pressure control. The homogenizer will be stopped when the red button is pressed. Press the red emergency stop button when the homogenizer needs to be stopped immediately under

special situation.

## 6.2 Operation instruction of the standard type homogenizer

### 1) Initialization stage of the system

First, connect to the electrical outlet; when the red power light is on, switch on the power at the left of the ultra-high pressure homogenizer. Once the touch screen of the homogenizer is started, all the indicator lights at the top right corner of the touch screen will be lit on, and the touch screen will show the initialization picture as following:



2) The display of the touch screen has three indicator lights on its top right corner. From left to right the three indicator lights are: RUN, the

PLC indicator light; COM, the communication light; PWR, the power indicator light of the touch screen. Then machine is ready when all the lights are lit on. Otherwise, inspection need and the equipment can be started until the fault is resolved.

### 6.3 User operation interface

1) A loading progress bar will be shown when initialization. After loading, the touch screen will enter the user operation interface as following:

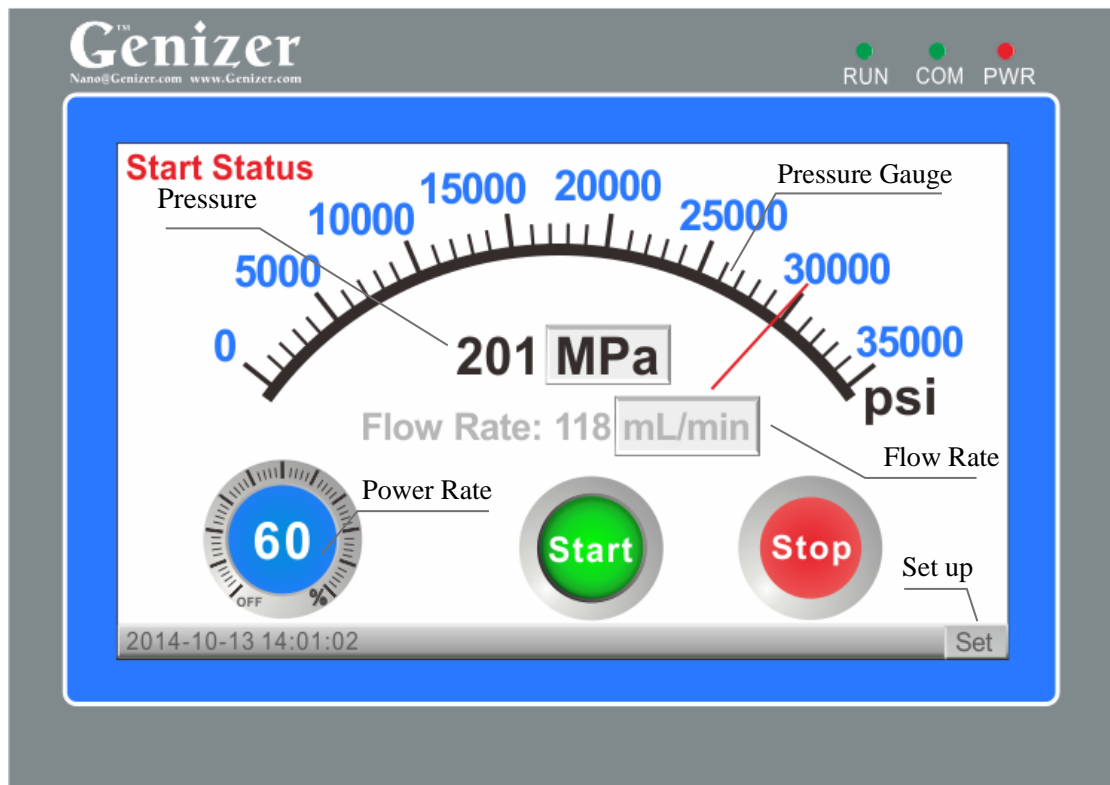

2) Digital pressure gauge: it indicates the pressure of the testing material.

3) Pressure value: it indicates the pressure value and the pressure unit can be converted mutually among kPsi, MPa and Bar when the pressure unit option is pressed.

4) Flow rate: it indicates the flow rate of the homogenizer and the unit of the flow rate can be converted mutually among mL/min, L/hr and Gal/hr.

5) Power: it can be adjusted to reach the needed pressure value according to the requirement of the user.

6) Start button: when it is pressed, the homogenizer will start running.

7) Stop button: when it is pressed, the homogenizer will stop. If any special situations, please press the emergency stop button for the emergency stop.

8) The parameter setting is divided to the customer setup and the factory setup. The setup interface may have some difference from the manual.





#### 6.4 Selection interface for the customer setup and the factory setup

When pressing Set in the user operation interface, the selection interface of the customer setup and the factory setup will be shown. (Attention: Correct password is needed before entering the factory setup interface)

The parameter setting interface has three buttons: the customer setup button, the factory setup button and the back button.

1) Click the customer setup button and then enter the interface of the customer setup;

2) Click the factory setup button, input the correct password and then

enter the interface of the factory setup;

3) Click the back button and then return to the previous menu.

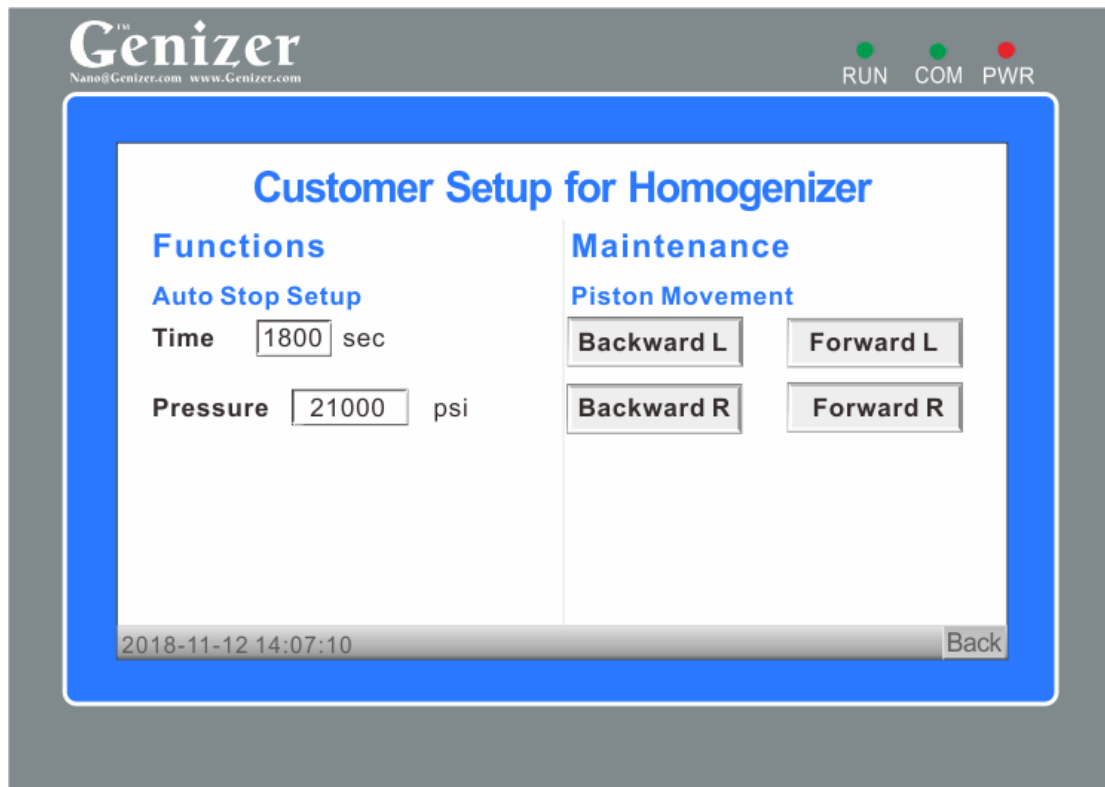

### 6.5 Parameter interface of customer setup

In the interface, the customer can set the running time (default as 1800 seconds); the total running flow volume (only for nanogenizer); safe pressure (once exceeding, the equipment will stop immediately); safe temperature (optional); volume of every stroke (only for nanogenizer); running times (only for nanogenizer); date; the pressure calibration button (only for nanogenizer); the automatic position calibration button (only for nanogenizer); the manual forward option and the manual backward

option; and the back button for returning to the previous menu.

1) Time: set the timing and press the Time button to start the timing function, and then press the start button to start timing. The equipment will stop automatically when the timing time is ended.

2) Volume: set the volume of the total flow materials which need processing, press the Volume button to open the calculating function of the flow volume and press the start button. When the calculating flow volume reaches the set value, the equipment will stop immediately.

3) Pressure: set the pressure value and press the Pressure button to open the safe pressure function, and then press the start button to compare the actual pressure with the safe pressure. When the actual pressure is higher than the safe pressure, the equipment will stop immediately.

4) Temperature: set the safe temperature value and press the Temp button to open the safe temperature function, and then press the start button to compare the actual temperature with the safe temperature. When the actual temperature is higher than the safe temperature, the equipment will stop immediately.

5) Stroke: set the volume of the stroke for small volume option.

6) Cycle times: set the cycle times and press the Cycle button to open the times-calculating function. Press the start button to calculate the times. The equipment will stop when the calculating times reaches the set value.



7) Date: it can set the year, month, day, hour, minute, second. After completing the setting, please click the Date button to save the setting.

8) Automatic position calibration: For position maintenance of the piston, please press the automatic position calibration function. This process may take up to one hour.

9) Go forward and go backward: use for the manual position calibration, the maintenance and debugging.

10) Click the Back button to return to the previous menu.

## 6.6 Parameter interface of factory setup

Contact the manufacture for the information of the factory setup.

## 6.7 Varieties of Inlet and Outlet for Pilot Genizer

Inlet: Tri clamp; Stainless Steel Cylinder

Outlet: Tri clamp; Stainless Steel Cylinder

When needs circulation operation for the testing material, please using a pipe to connect the Tri clamp outlet into the top of the inlet cylinder.



## **7. Trouble Shootings**

### 7.1 Mechanical Trouble Shootings

#### 7.1.1 Air-blocking and chamber-blocking and overload

Our design has minimized the occurrence of the air-blocking, chamber-blocking and overload. However, the improper operation of the homogenizer can still induce the error and damage of the homogenizer.

##### 1) Air Blocking

Symptom: There is no pressure or there is no sucking from inlet.

Prevention: Do not running with empty inlet.

Reason: There is air inside the pump.

Solution: Push the Ball in the inlet valve with a pin.

##### 2) Chamber Blocking

Symptom: Overload of the pressure.

Prevention: Pre-treat the sample carefully; Reduce the speed.

Reason: There is aggregates or particles in the sample; Too much speed.

Solution: Reverse flow the outlet valve with water with low speed.

##### 3) Overload

Solution: Reduce the speed and close the power, wait 30 sec and restart again; or Wash with water or your solvent; or Running with clean

and homo-disperse sample.

7.1.2 When the pressure is down:

1) Circuit fault: check whether all the indicator lights are working well.

2) Fault of high pressure pump body: check whether the high pressure pump body is working well.

3) Fault of the inlet flow: check whether the one-way check valve is working well.

4) Leaking of the hydraulic system: check whether every joint is connected correctly.

7.1.3 When the high pressure pump sending out abnormal noise:

1) If the high pressure pump body lacks lubrication, please add the lubricant into the grease inlet (a) of the pressure enhancer as shown in the detailed part drawing. In the figure of detailed parts drawing, (a) is the grease inlet of the pressure enhancer system.

2) If the high pressure pump has foreign matters or serious abrasion, it should be returned to the factory for repair.

## 7.2 Trouble Shootings of electric appliance

7.2.1 The red switch of the power supply does not light on

1) If the fuse is blowout, please replace the fuse.

2) If the equipment is not connected with power supply, please connect it with the power supply.

3) If the outlet is not plugged well, please plug it again.

7.2.2 If the RUN light, COM light and the POWER light of the touch screen do not light on.

1) Please check whether touch screen is connected with power supply or not.

2) If the touch screen is going wrong, please contact the customer service.

7.2.3 If the equipment does not work when pressing the green button, please turn off the power supply and restart it after 30 seconds.  The control systems need a few seconds for rebuilding. If the problem remains, please contact the customer service.

## **8. Maintenance**

8.1 Please clean the equipment before closing the system. Please use the solvent, alcohol and water in turn for flushing. Do not let the material stay for a long time, especially the viscous or indurate material.

8.2 **Attention**  : Service or maintenance work is prohibited when the system is running.



8.3 **Attention**  : Ensure that the pressure of the system has been released and the power supply has been turned off safely before implementing the service or maintenance work.

8.4 Some of the high pressure components have a leakage hole. Please check regularly whether the system is leaking or not, please turn off the equipment once leaking. Because the system is operating under the high pressure, even the little leakage would damage the sealing element in a few minutes.

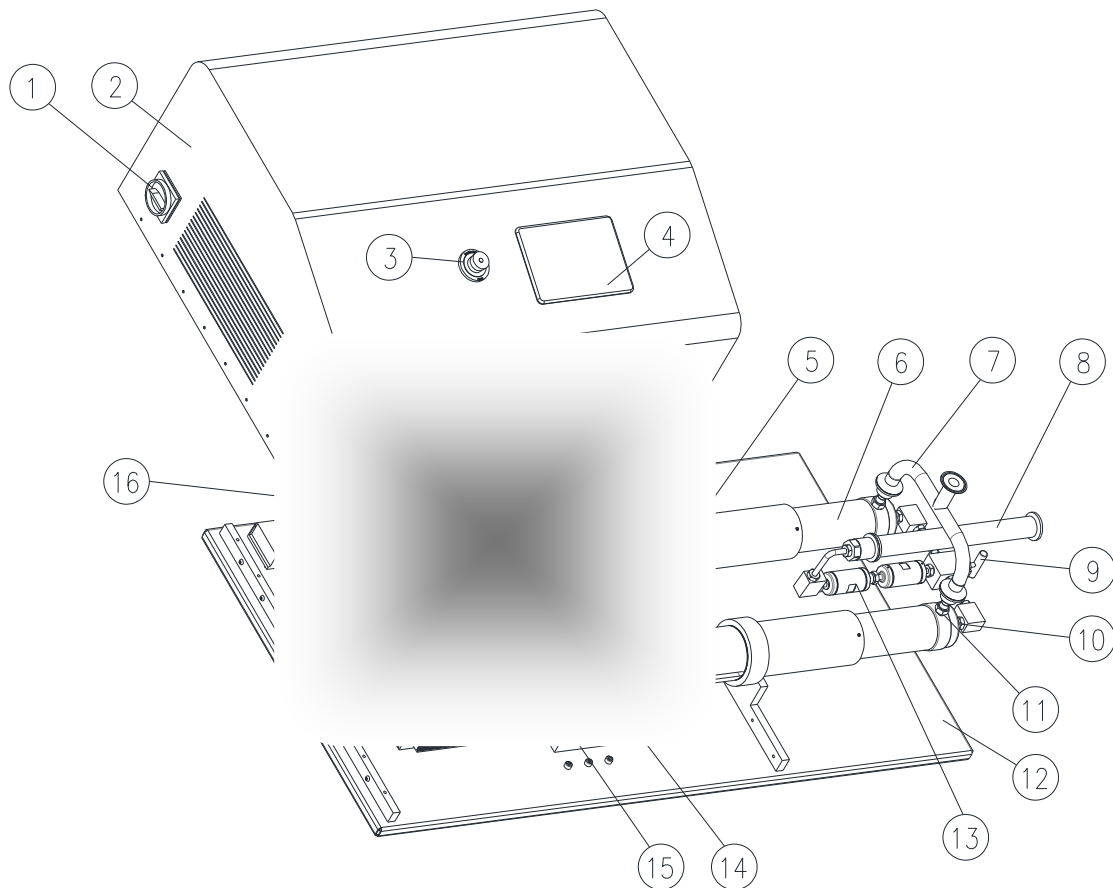

### Detailed parts drawing of the standard type PilotGenizer

List of the replacement components			
Item	Component model	Quantity	Component name
1	PIG-PS	1	Power Switch
2	PIG-UC	1	Up Cover
3	PIG-ES	1	Emergency stop
4	PIG-TS	1	Touch screen
5	PIG-CC	2	Connecting Cylinder
6	PIG-HC	2	High Pressure Cylinder
7	PIG-3WTC	1	Inlet 3 way Tri-clamp
8	PIG-HE	1	Sanitary Heat Exchanger
9	PIG-PV	1	Priming valve
10	PIG-ICV	2	Inlet Check Valve
11	PIG-OCV	2	Outlet Check Valve
12	PIG-BP	1	Base Plate
13	PIG-IXC	2	Interaction Chamber
14	PIG-BS	2	Bearing Seat
15	PIG-M	2	Motor
16	PIG-CU	2	Control Unit
17			
18			

Components: A set of disassembly tools for seal parts, an Allen wrench, and a set of seal parts.

Remarks: the 1L cylinder can be replaced by other containers.

Note: 1. The specification, structure and parameter may be modified without notification.

2. The Dimensions, structure and parameter should be subject to the final product.